

Natural Sound 2/4 Channel Power Amplifier

YAMAHA M-35

CENTER

Thank you for purchasing the YAMAHA M-35 power amplifier.

CONTENTS

SAFETY INSTRUCTIONS	1
CAUTION: READ THIS BEFORE OPERATING YOUR M-35	2
NAME OF PARTS AND CONTROLS	3
CONNECTIONS	5
SPECIFICATIONS	7
TROUBLESHOOTING	8



OWNER'S MANUAL

IMPORTANT

Please check your unit's rear panel serial number and record it in the space below.

Model: **M-35**
Serial No.:

Keep this owner's manual in a safe place for future reference.

WARNING

To prevent fire or shock hazard, do not expose this appliance to rain or moisture.

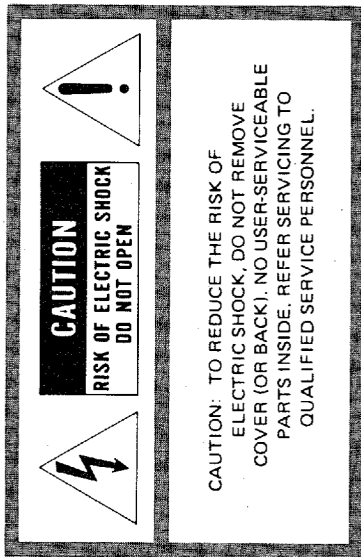

• **Explanation of Graphical Symbols**

The lightning flash with arrowhead symbol, within an equilateral triangle, is intended to alert you to the presence of uninsulated "dangerous voltage" within the product's enclosure that may be of sufficient magnitude to constitute a risk of electric shock to persons.

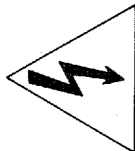

The exclamation point within an equilateral triangle is intended to alert you to the presence of important operating and maintenance (servicing) instructions in the literature accompanying the appliance.

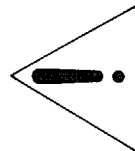

SAFETY INSTRUCTIONS

- 1 **Read Instructions** — All the safety and operating instructions should be read before the appliance is operated.
- 2 **Retain Instructions** — The safety and operating instructions should be retained for future reference.
- 3 **Heed Warnings** — All warnings on the appliance and in the operating instructions should be adhered to.
- 4 **Follow Instructions** — All operating and other instructions should be followed.
- 5 **Water and Moisture** — The appliance should not be used near water — for example, near a bathtub, washbowl, kitchen sink, laundry tub, in a wet basement, or near a swimming pool, etc.
- 6 **Carts and Stands** — The appliance should be used only with a cart or stand that is recommended by the manufacturer.
- 7 **Wall or Ceiling Mounting** — The appliance should be mounted to a wall or ceiling only as recommended by the manufacturer.
- 8 **Ventilation** — The appliance should be situated so that its location or position does not interfere with its proper ventilation. For example, the appliance should not be situated on a bed, sofa, rug, or similar surface, that may block the ventilation openings; or cabinet that may impede the flow of air through the ventilation openings.
- 9 **Heat** — The appliance should be situated away from heat sources such as radiators, stoves, or other appliances that produce heat.
- 10 **Power Sources** — The appliance should be connected to a power supply only of the type described in the operating instructions or as marked on the appliance.
- 11 **Power-Cord Protection** — Power-supply cords should be routed so that they are not likely to be walked on or pinched by items placed upon or against them, paying particular attention to cords at plugs, convenience receptacles, and the point where they exit from the appliance.
- 12 **Cleaning** — The appliance should be cleaned only as recommended by the manufacturer.
- 13 **Nonuse Periods** — The power cord of the appliance should be unplugged from the outlet when left unused for a long period of time.
- 14 **Object and Liquid Entry** — Care should be taken so that objects do not fall into and liquids are not spilled into the inside of the appliance.
- 15 **Damage Requiring Service** — The appliance should be serviced by qualified service personnel when:
 - A. The power-supply cord or the plug has been damaged; or
 - B. Objects have fallen, or liquid has been spilled into the appliance; or
 - C. The appliance has been exposed to rain; or
 - D. The appliance does not appear to operate normally or exhibits a marked change in performance; or
 - E. The appliance has been dropped, or the cabinet damaged.

CAUTION: READ THIS BEFORE OPERATING YOUR M-35

- 16 Servicing — The user should not attempt to service the appliance beyond those means described in the operating instructions. All other servicing should be referred to qualified service personnel.
- 17 Power Lines — An outdoor antenna should be located away from power lines.
- 18 Grounding or Polarization — The precautions that should be taken so that the grounding or polarization of an appliance is not defeated.

- 1 To ensure the finest performance, please read this manual carefully. Keep it in a safe place for future reference.
- 2 Install your unit in a cool, dry, clean place—away from windows, heat sources, and too much vibration, dust, moisture or cold. Avoid sources of hum (transformers, motors). To prevent fire or electrical shock, do not expose to rain and water.
- 3 Do not operate the amplifier upside-down. It may overheat, possibly causing damage.
- 4 Never open the cabinet. If a foreign object drops into the set, contact your dealer.
- 5 Do not place records or other objects on top of the amplifier; this will block the ventilation holes, cause the internal temperature to rise and may result in a failure.
- 6 Do not use force on switches, knobs or cords. When moving the set, first turn the unit off. Then gently disconnect the power plug and the cords connecting to other equipment. Never pull the cord itself.
- 7 Do not attempt to clean the unit with chemical solvents; this might damage the finish. Use a clean, dry cloth.
- 8 Be sure to read the "troubleshooting" section on common operating errors before concluding that your unit is faulty.
- 9 Do not connect audio equipment to the AC outlets on the rear panel if that equipment requires more power than the outlets are rated to provide.

M-35

NAME OF PARTS AND CONTROLS

FRONT PANEL

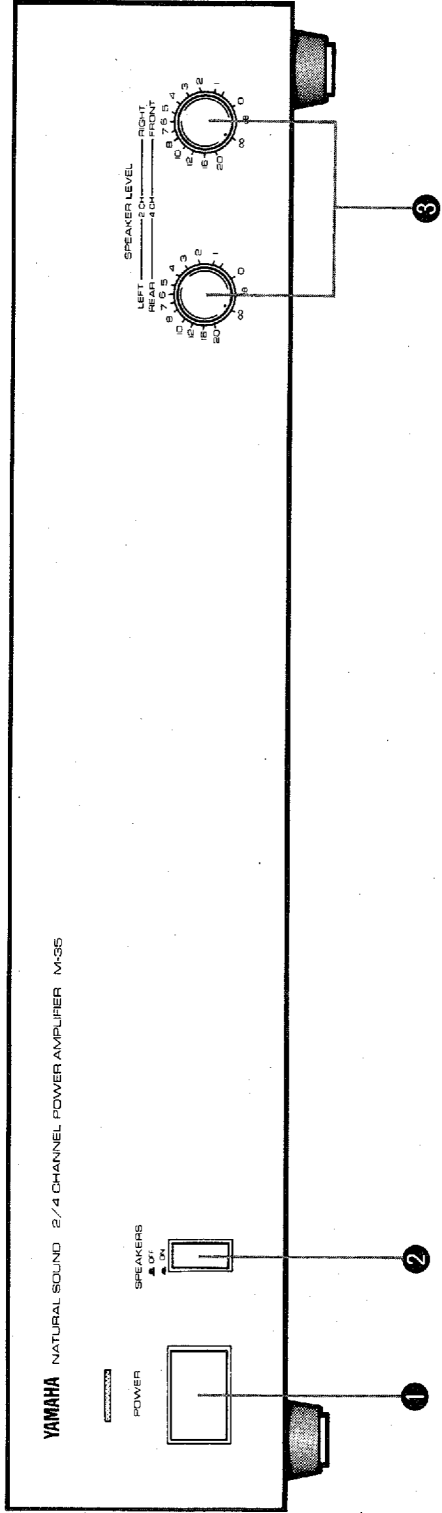

1 POWER switch

Press the switch to turn the power on, and the indicator above it will light. Pressing it again turns power off.

- * Before turning power on, be sure to set the volume control of the control amplifier, surround processor, etc. to the minimum position in order to prevent pop noise.
- * With the function of the speaker protection circuit, sound is not produced for a few seconds after turning the power on.

2 SPEAKERS switch

Press to turn on-off the speaker system connected to the M-35. Sound is produced when this switch is ON (—) and muted when it is OFF (—).

3 SPEAKER LEVEL controls

These adjust the speaker volumes. Sound from the speakers increases when the controls are turned clockwise. The function of these controls varies in the 2 CH and 4 CH operations as described below.

• 2 CH operation:

The control on the right adjusts the volume of the RIGHT speaker, and the control on the left adjusts the volume of the LEFT speaker.

• 4 CH operation:

The control on the right adjusts the volume of the FRONT speakers, and the control on the left adjusts the volume of the REAR speakers.

- * With 4 CH operation, the left and right balance cannot be adjusted with this power amplifier. Adjust it on the control amplifier.
- * Normally set the controls to the fully clockwise (0 dB) position, and turn the left control counterclockwise when it is necessary to adjust the front and rear balance. The overall volume should be adjusted with the volume controls of the control amplifier.

M-35

REAR PANEL

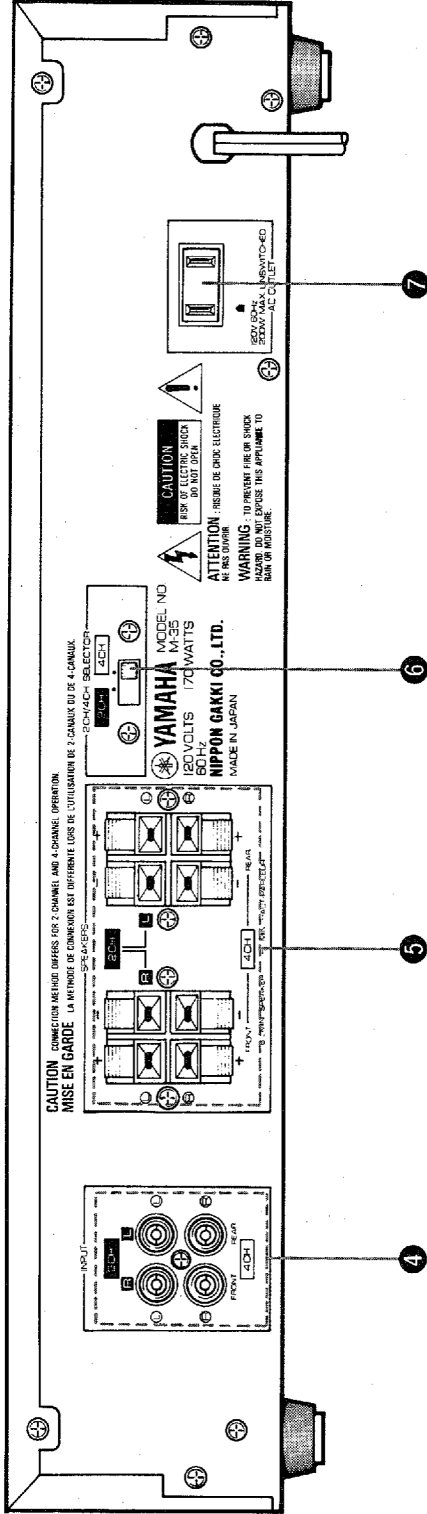

4 INPUT jacks

Connect the control amplifier or surround processor, etc., to these jacks. The connection methods for the 2 CH and 4 CH operations are different.

* Refer to "CONNECTIONS" on page 5.

5 SPEAKERS terminals

Connect speakers to these terminals. Similarly to the INPUT jacks, the connection methods for the 2 CH and 4 CH operations are different.

* Refer to "CONNECTIONS" on page 5.

6 2 CH/4 CH SELECTOR switch

Place the switch to "2 CH" for 2-channel operation and to "4 CH" for 4-channel operation.

7 AC OUTLET

This is the supplementary power outlet that can supply power to other audio equipment. It is not controlled the setting of the M-35's POWER switch and can supply a maximum power of 200W.

M-35

CONNECTIONS

- * Turn off the power of the equipment before connecting them, and connect correctly by confirming FRONT, REAR, LEFT and RIGHT.
- * The connection methods and operation methods are different in 2-channel (2 CH) and 4-channel (4 CH) operations.

■ CONNECTION FOR 4-CHANNEL OPERATION

1. Set the 2 CH/4 CH SELECTOR switch to "4 CH".
2. Connect the control amplifier's PRE OUT jacks to the M-35 INPUT jacks.
3. Connect speakers to the SPEAKERS terminals of the M-35.

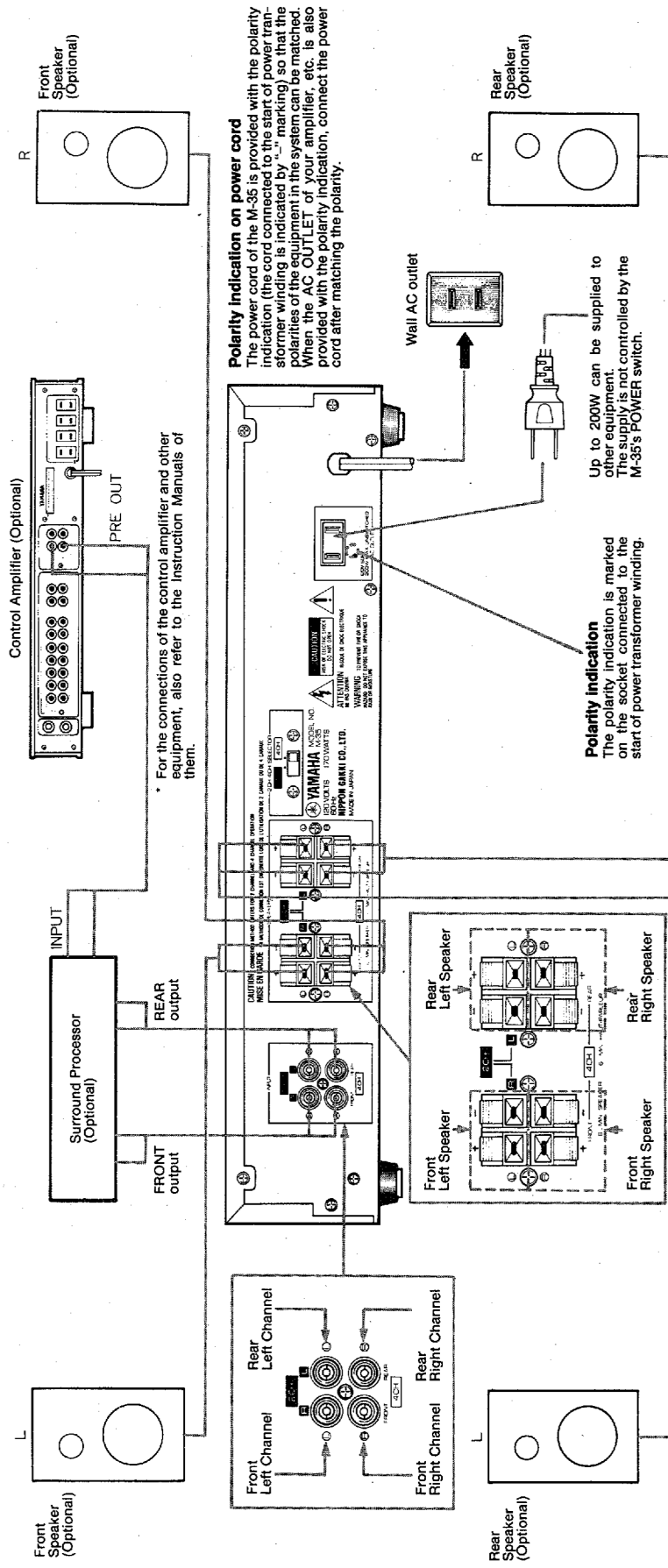

■ CONNECTION FOR 2-CHANNEL OPERATION

1. Set the 2 CH/4 CH SELECTOR switch to "2 CH".
2. Connect the control amplifier's PRE OUT jacks to the M-35 INPUT jacks.
3. Connect speakers to the SPEAKERS terminals of the M-35.

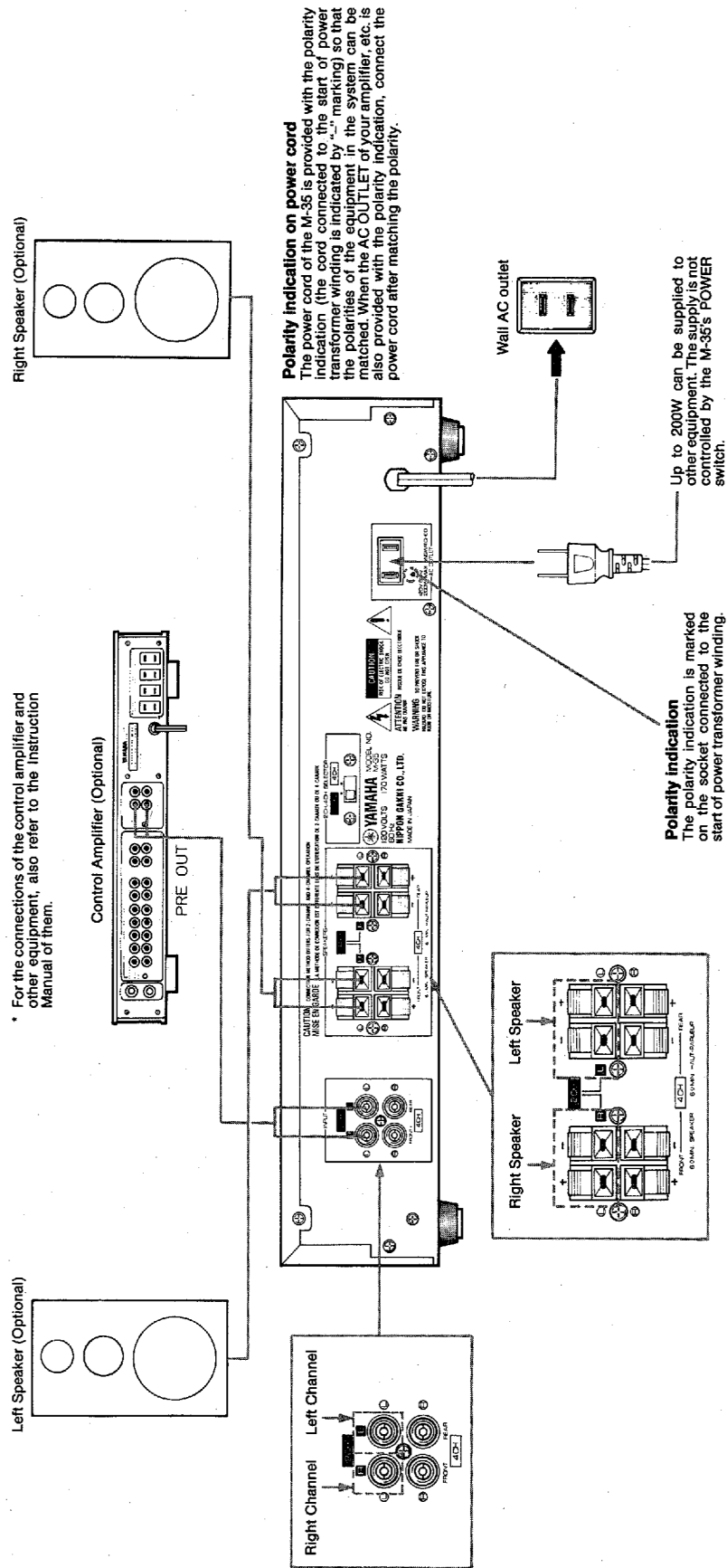

SPECIFICATIONS

■ SPEAKER CONNECTION

1. Peel off the insulation on the end of each speaker cord by around 10 mm.
2. As shown in the illustration, insert the conductor of the speaker into the terminal hole while pushing the lever above it. After inserting, the code is locked by releasing the lever.

Red: +
Black: -

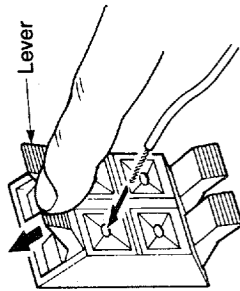

The speaker cord distances should be as short as possible.

- * Take care for the polarity of connection. If it is inverse, the reproduced sound will be unnatural, with lack of stereo effect, sound localization on the center and spoiled bass tones.
- * Use speakers having the impedances within the specified range.
- * When connecting, be careful that the exposed speaker conductor does not contact other terminals.

Rated Output	
Minimum RMS output power per channel	
2 CH (20 Hz ~ 20 kHz)	40W
0.05% THD, 8 ohms	43W
4 CH (20 Hz ~ 20 kHz)	
0.07% THD, 8 ohms	20W
0.08% THD, 6 ohms	22W
Dynamic Power	
2 CH (1 kHz, 8 ohms/6 ohms)	57W/70W
4 CH (1 kHz, 8 ohms/6 ohms)	32W/37W
Dynamic Headroom	
2 CH (8 ohms)	1.54 dB
4 CH (8 ohms)	2.04 dB
Power Bandwidth	
2 CH (0.18% THD, 20W/8 ohms)	10 Hz ~ 50 kHz
4 CH (0.18% THD, 10W/8 ohms)	10 Hz ~ 40 kHz
Damping Factor (1 kHz, 8 ohms)	70
Input Sensitivity/Input Impedance	
2 CH	1.0V/20 k-ohms
4 CH	0.7V/20 k-ohms
Frequency Response	
(20 Hz to 20 kHz)	+0/-0.3 dB
Total Harmonic Distortion	
2 CH (1 kHz, 20W/8 ohms)	0.008%
4 CH (1 kHz, 10W/8 ohms)	0.015%
Signal-to-Noise Ratio (IHF-A-Network, input short-circuited)	
2 CH	120 dB
4 CH	113 dB

Residual noise (IHF-A-Network)	18 μ V
Channel Separation (1 kHz, Vol. -30 dB, 5.1 k-ohms terminated)	
2 CH	70 dB
4 CH	55 dB
Rated Supply Consumption	AC 120V, 60 Hz
Rated Power Consumption	170W
AC Outlet (UNSWITCHED X 1)	200W max.
Dimensions (W x H x D)	435 x 92.5 x 286.7 mm (17-1/8" x 3-11/16" x 11-5/16")
Weight	5.0 kg (11 lb)

* Design and specifications subject to change without notice.

M-35

TROUBLESHOOTING

When malfunction occurs in the operation of the M-35 power amplifier, first check the followings. If the malfunction still persists after checking or if it is a malfunction which is not listed below, turn the POWER switch off, disconnect the power cord from the power supply outlet, and consult your dealer or nearest YAMAHA audio products service agent.

Symptom	Check	Remedy
Power cannot be turned ON by pressing the POWER switch.	<ul style="list-style-type: none">• The power plug is not connected securely to the power outlet.	<ul style="list-style-type: none">• Insert the power plug securely into the power outlet.
Sound is not heard at all.	<ul style="list-style-type: none">• The SPEAKERS switch is OFF.• The SPEAKER LEVEL controls are in the fully $-\infty$ positions.• Pin plugs are not connected securely to the INPUT jacks.• Speakers are not connected properly to the amplifier.• Speakers are not connected properly to the amplifier.	<ul style="list-style-type: none">• Press the SPEAKERS switch to ON.• Turn the SPEAKER LEVEL controls clockwise.• Insert the pin plugs securely into the jacks.• Check the connection.• Check the connection.
Sound is not produced from the front and/or rear speakers or left and/or right speakers.	<ul style="list-style-type: none">• One of the SPEAKER LEVEL controls is in the fully counterclockwise position.• The 2 CH/4 CH SELECTOR switch is not set correctly.	<ul style="list-style-type: none">• Turn the SPEAKER LEVEL control clockwise.• Set the 2 CH/4 CH SELECTOR switch correctly.
The balance between the left and right cannot be adjusted in the 4 CH operation.	<ul style="list-style-type: none">• In the 4 CH operation, the left and right balance cannot be adjusted from the M-35 power amplifier.	<ul style="list-style-type: none">• Adjust the left and right balance from the control amplifier.
The acoustic image is unstable, with unnatural sound lacking bass tone.	<ul style="list-style-type: none">• The phases (+ & -) of the amplifier and speakers are not matched.	<ul style="list-style-type: none">• Connect the speakers to the amplifier again by matching the phases (+ & -).
Hum noise is heard from the speakers.	<ul style="list-style-type: none">• Pin plugs are not connected properly.	<ul style="list-style-type: none">• Insert the pin plugs securely into the jacks.

SINCE 1887
 **YAMAHA**
NIPPON GAKKI CO., LTD. HAMAMATSU, JAPAN